

# Autobus Parisien Renault TN6

RESINE

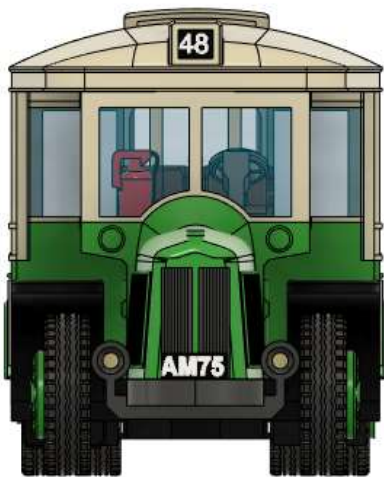

# Autobus Parisien Renault TN6

RESINE

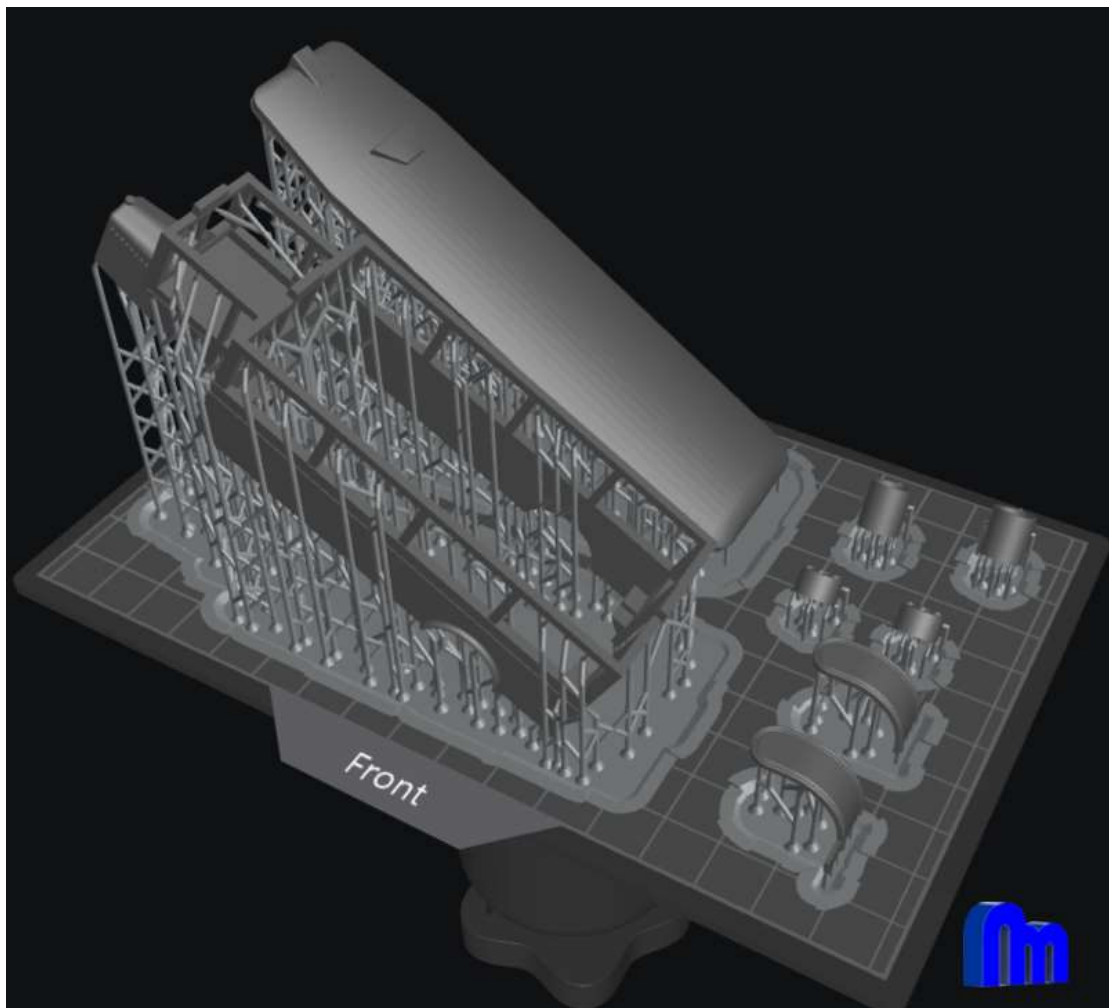
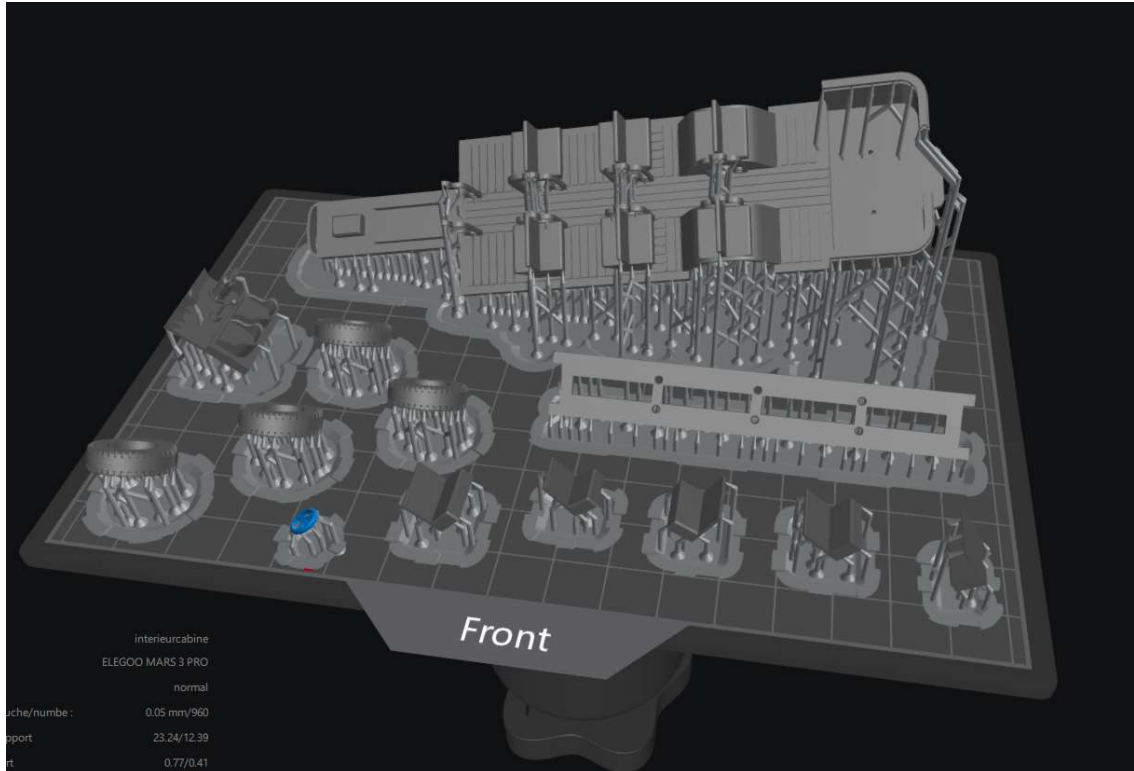

# Autobus Parisien Renault TN6

## RESINE

1

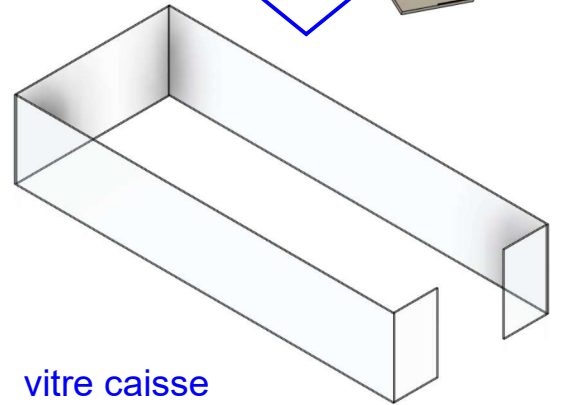
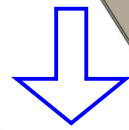
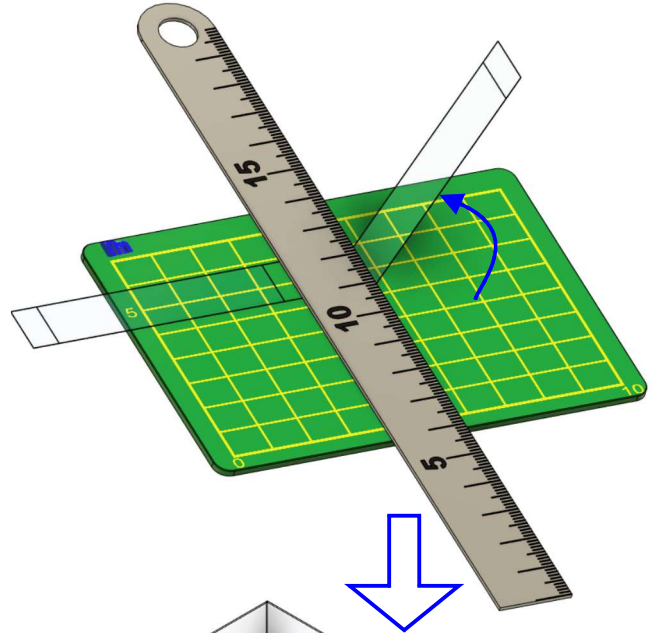
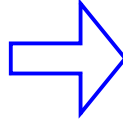
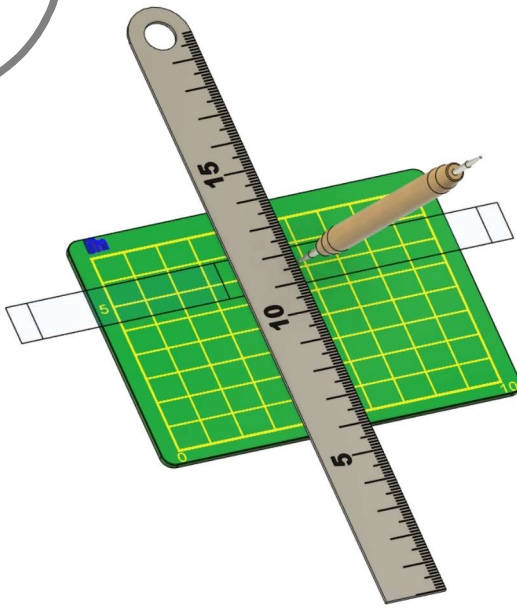

Marquer les plis avec un poinçon fin, on peut aussi utiliser un stylo bille usagé.

*Mark the folds with a fine punch, you can also use a used ballpoint pen.*

vitre.png

vitre caisse

2

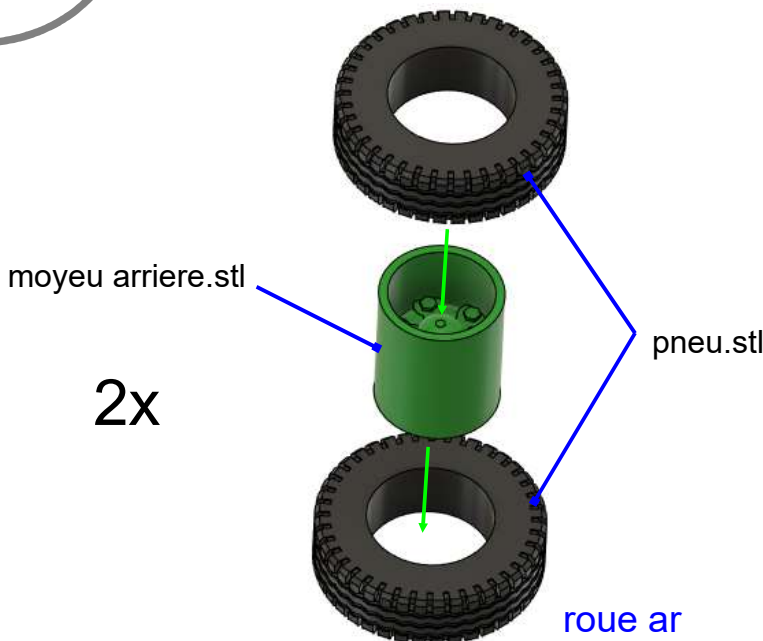

moyeu arriere.stl

pneu.stl

2x

roue ar

3

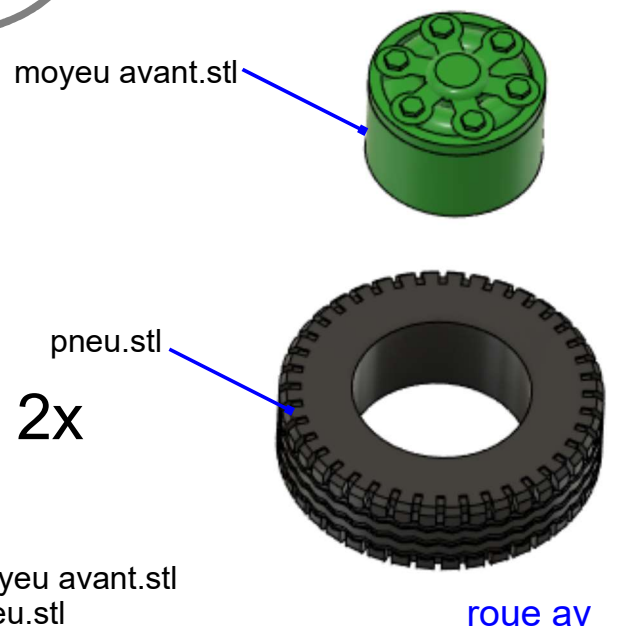

moyeu avant.stl

pneu.stl

2x

moyeu avant.stl  
pneu.stl

roue av

# Autobus Parisien Renault TN6

## RESINE

4

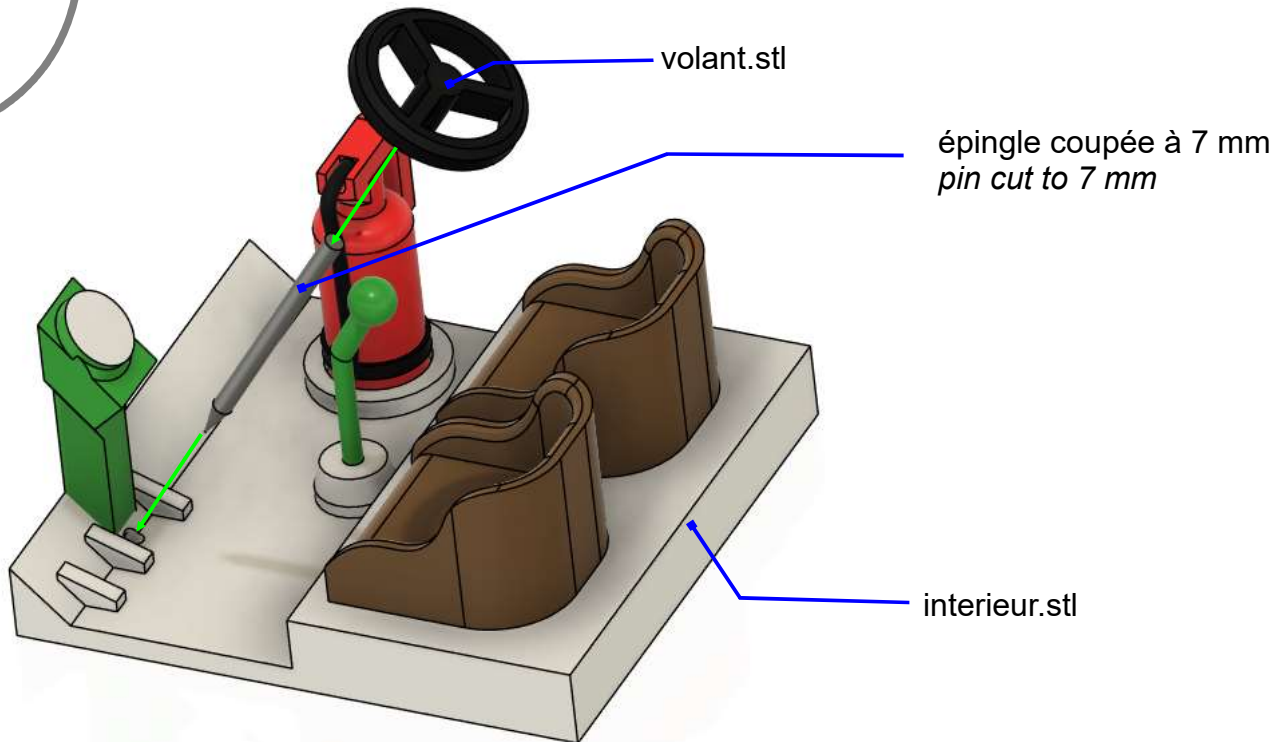

5

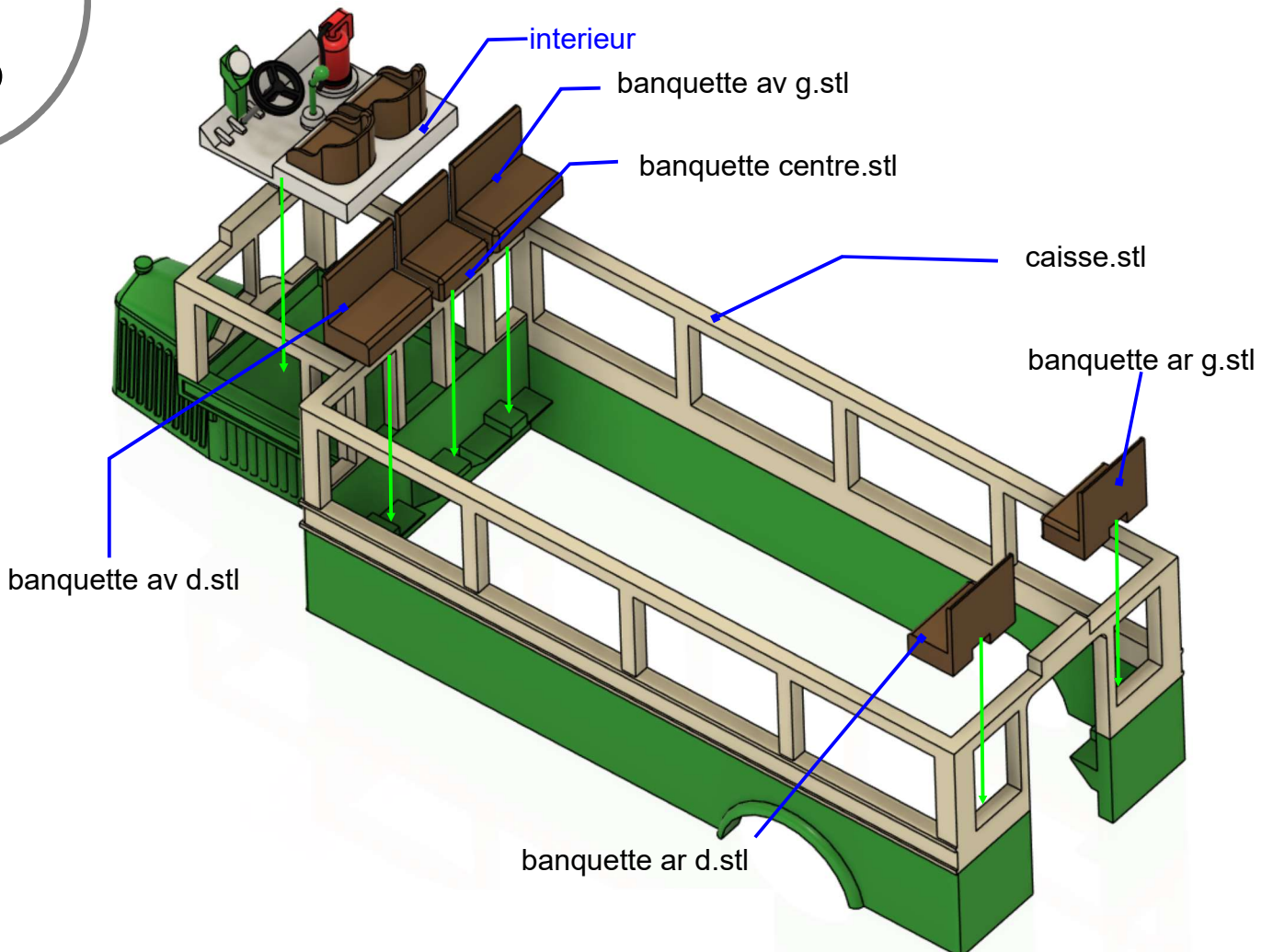

# Autobus Parisien Renault TN6

RESINE

6

caisse

chassis.stl

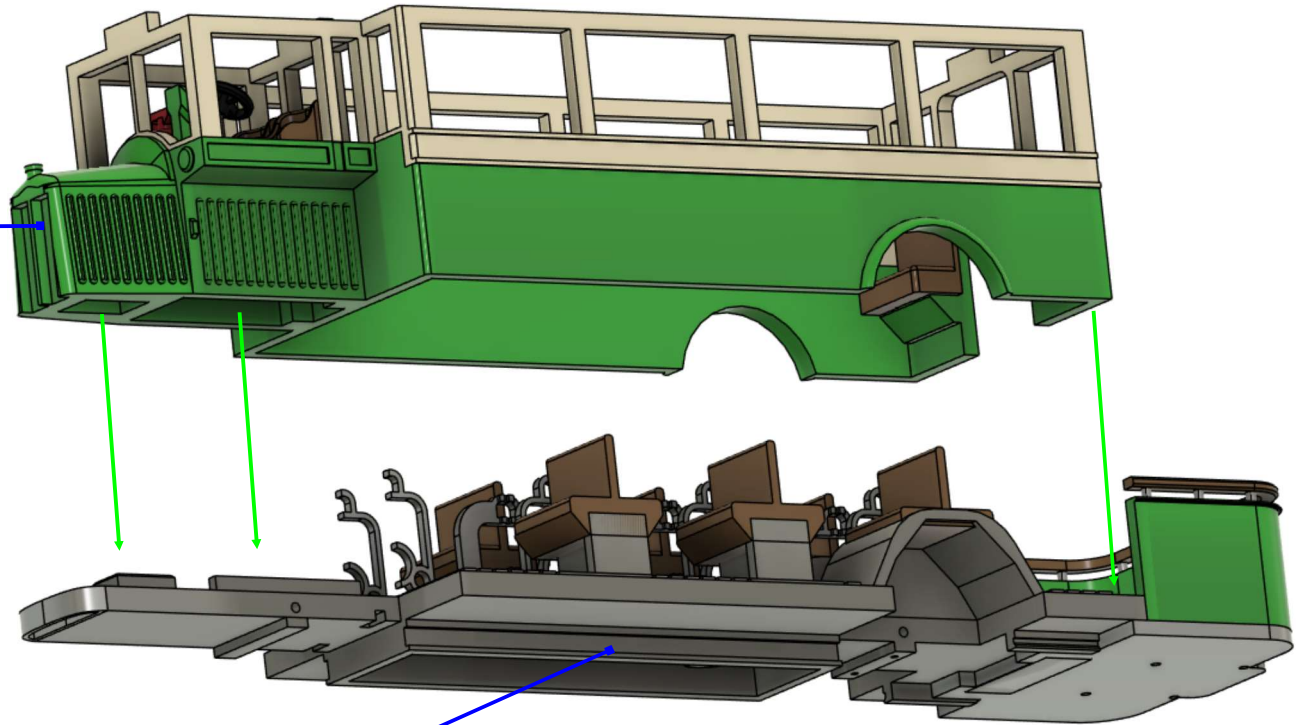

7

vitre.png

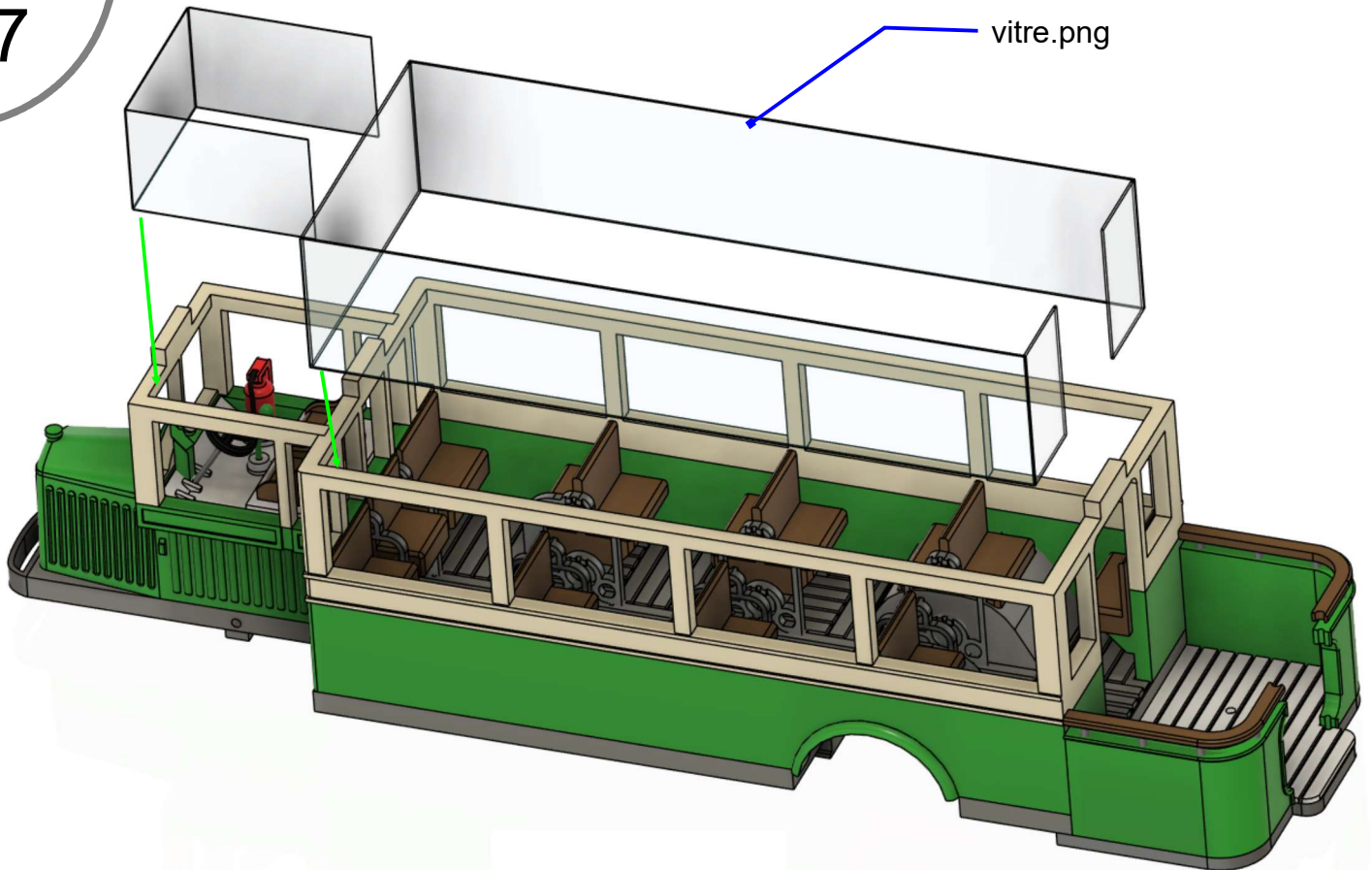

# Autobus Parisien Renault TN6

RESINE

8

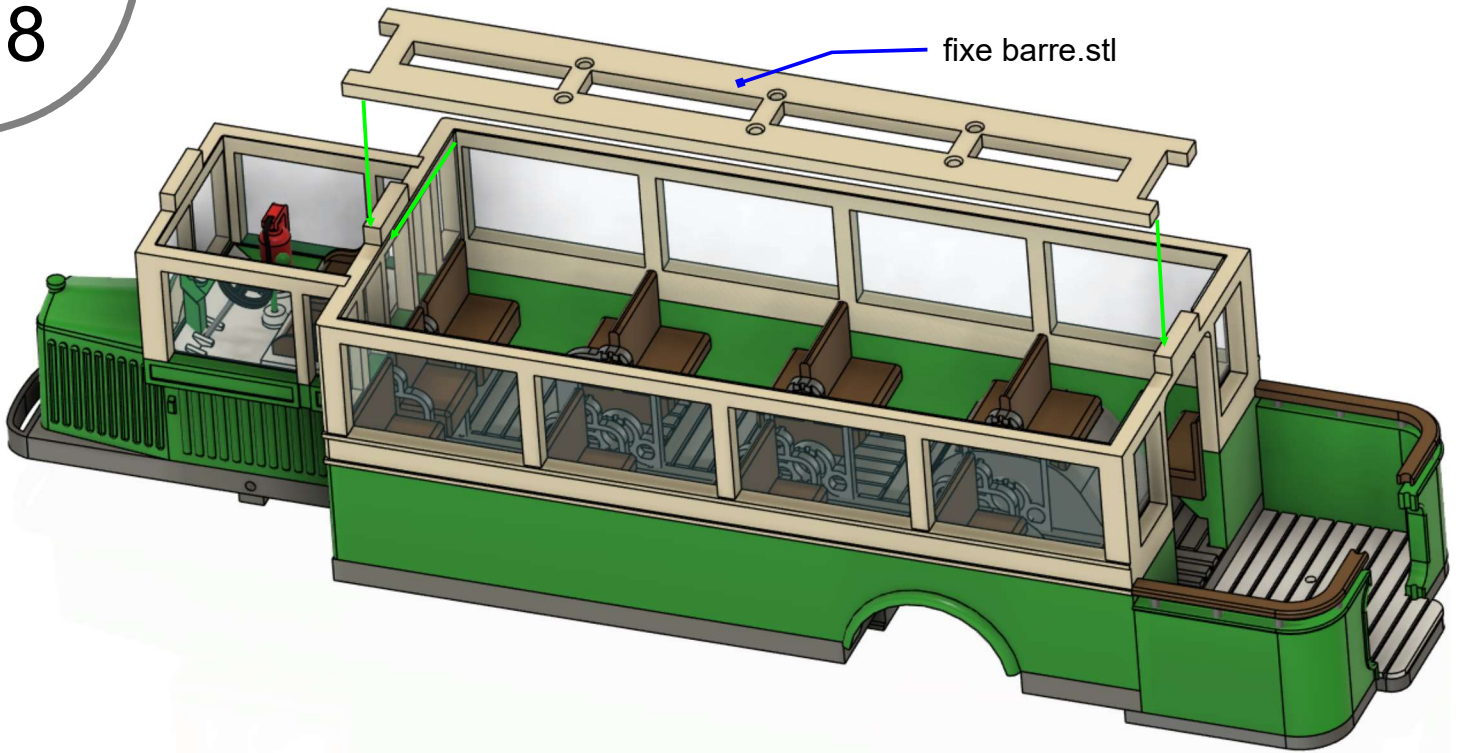

9

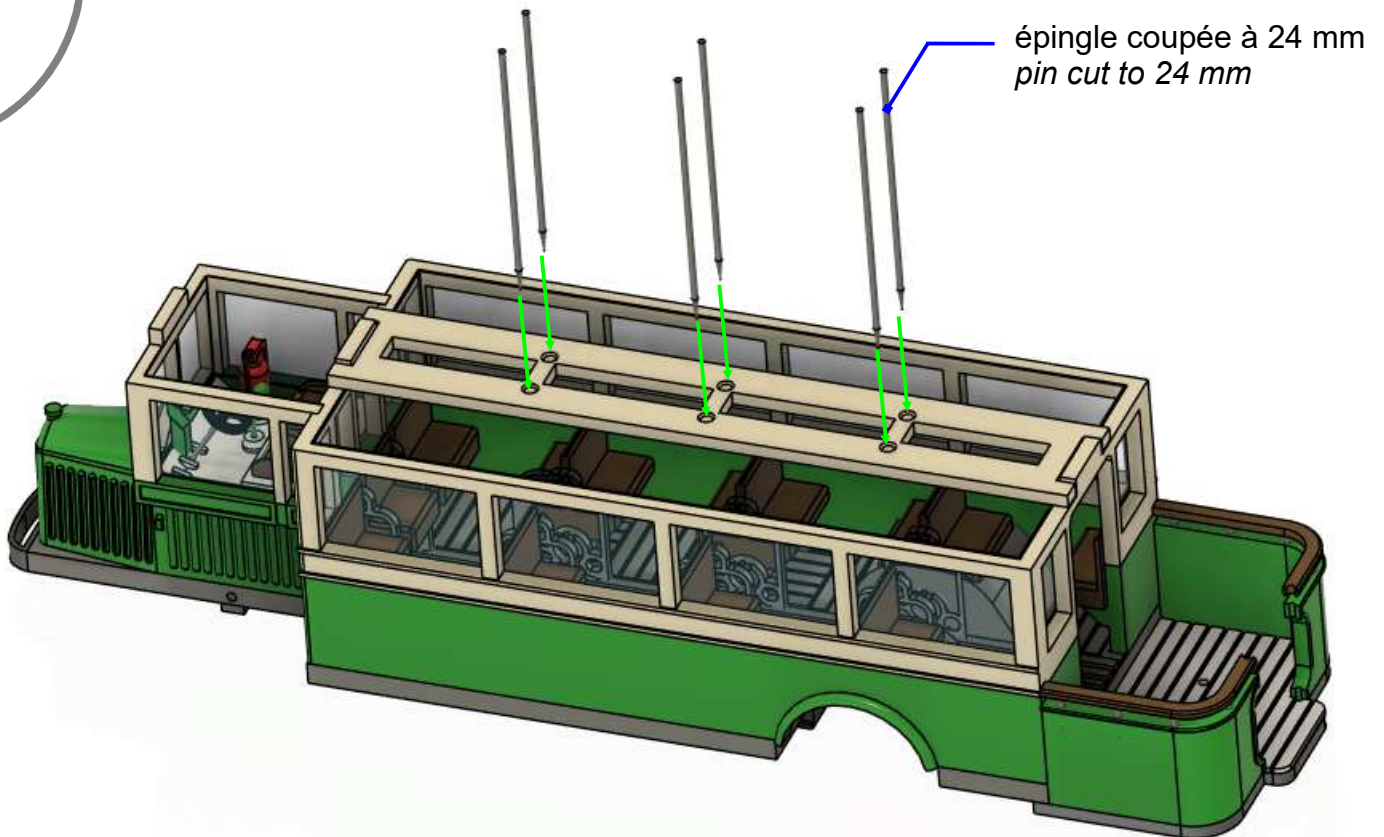

# Autobus Parisien Renault TN6

RESINE

10

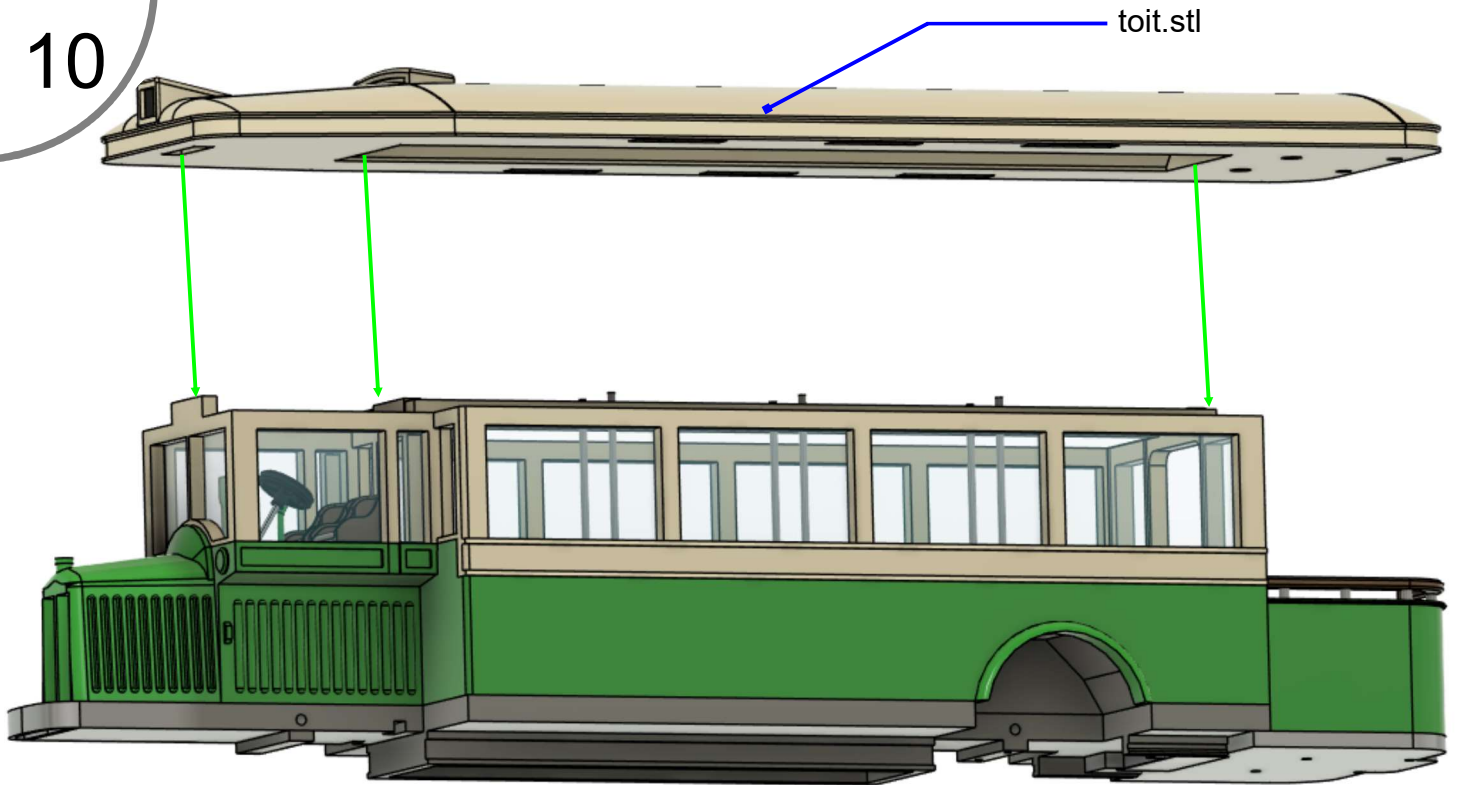

11

épingles coupées à 26 mm  
pin cut to 26 mm

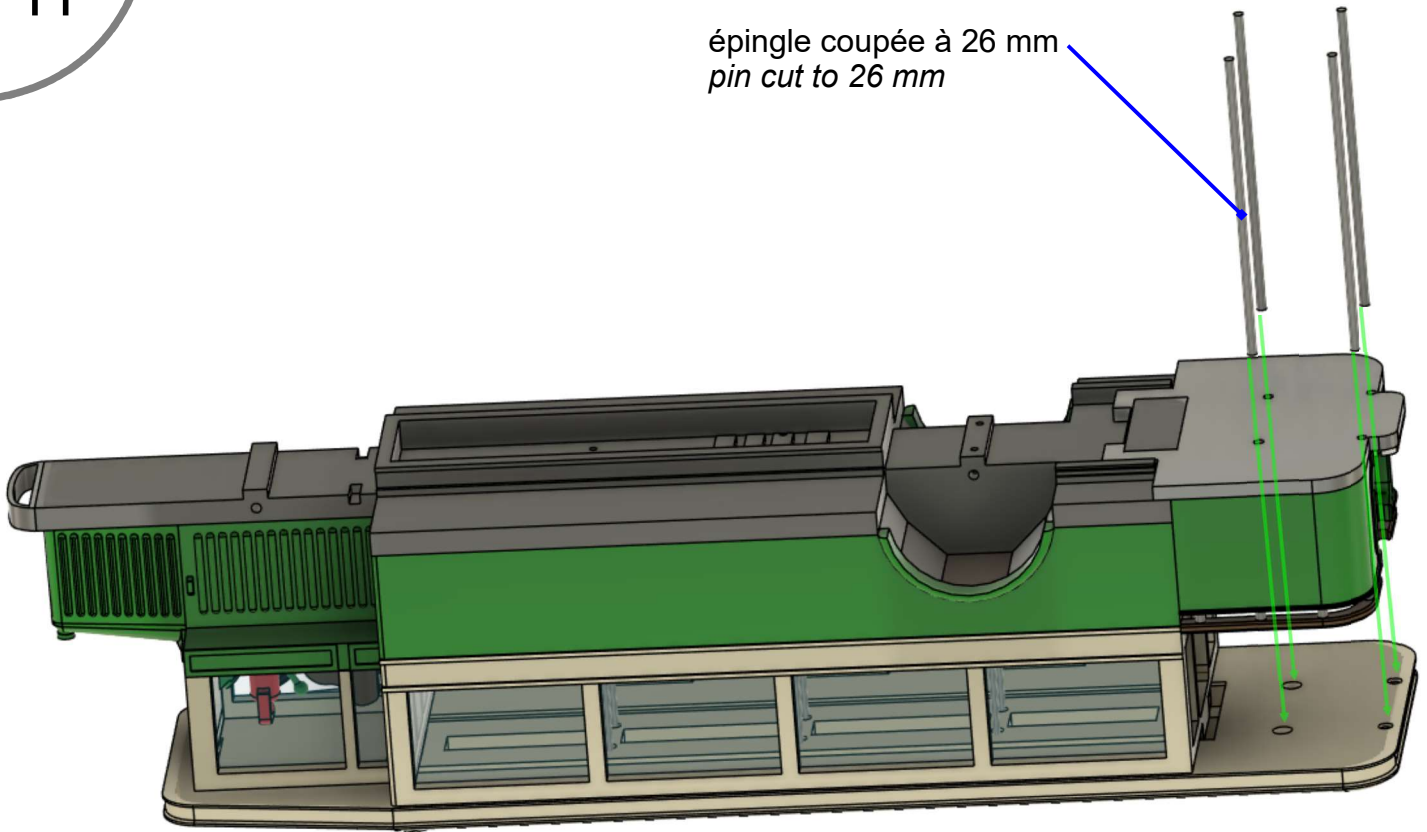

# Autobus Parisien Renault TN6

RESINE

12

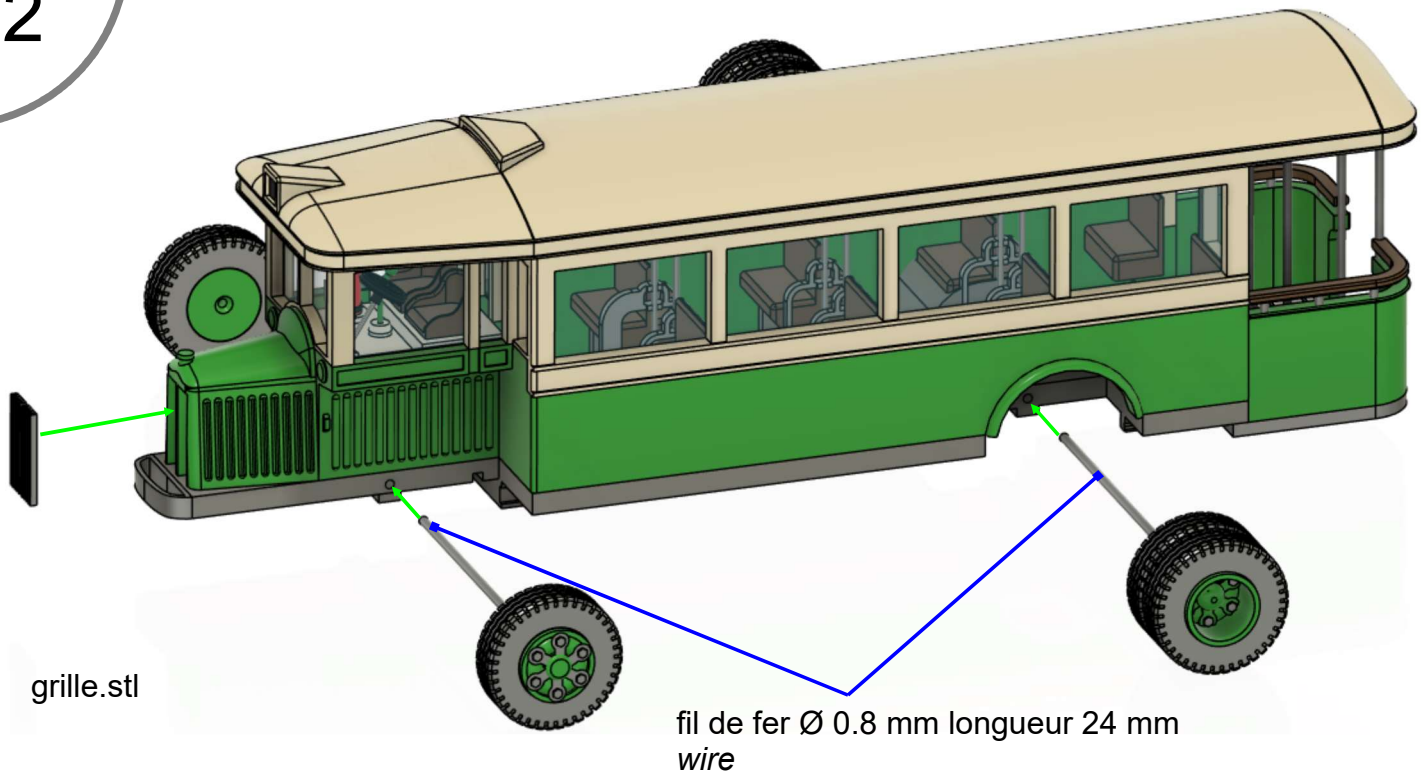

13

